

Conector de expansión

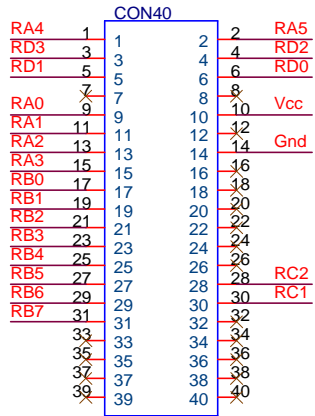

TECLADO1

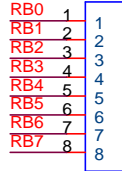

Selector de salida Display / LEDS

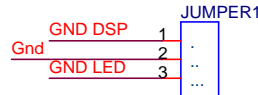

Salidas Digitales (Display)

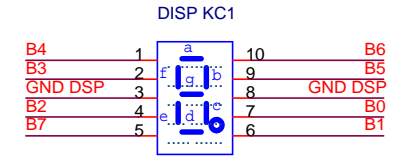

Entrada Digital RB0

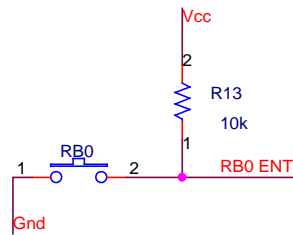

Selector RB0 Entrada / Salida

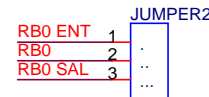

Salidas Digitales (LEDs)

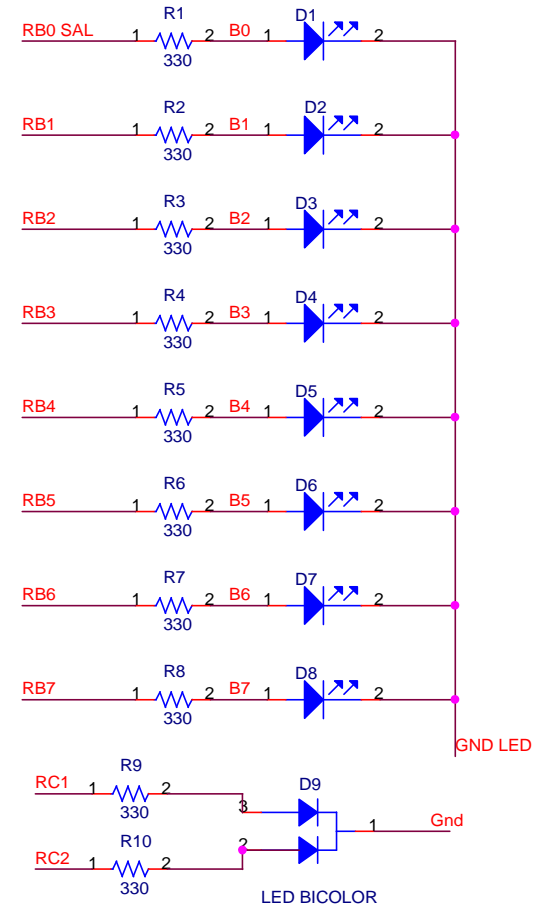

Entradas Digitales RA3 y RA4

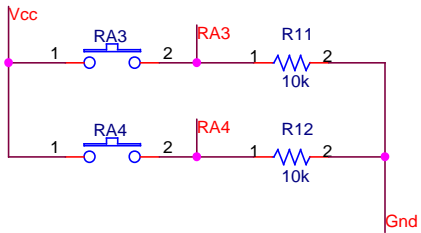

Entradas Digitales RD0 a RD3

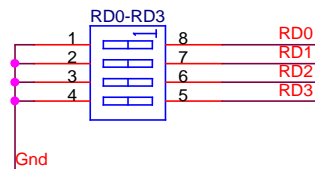

Altavoz

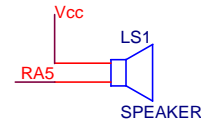

Entradas Analógicas

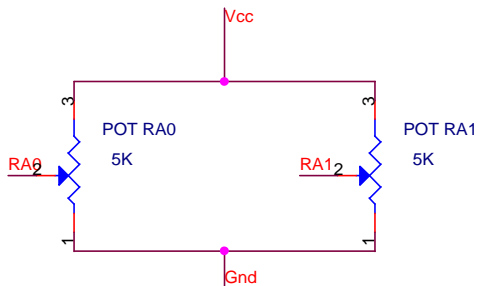

Sensor de Infrarrojos

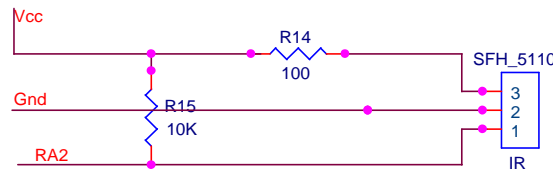

IES Luis de Lucena
Dpto. Electronica

**PLATAFORMA
PLUMBOT**